

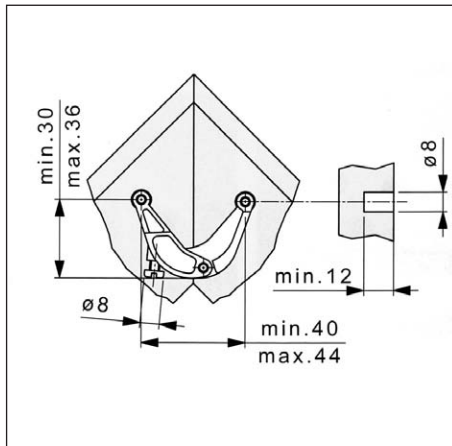

Köldökcsap
 méret: $\varnothing 8 \times 35$ mm
 anyag: bükk
 rendelés: 10kg/csomag
 (kb. 8500 db)
00003320000



Lapostipli
 méret: 20-as, 56x24 mm
 anyag: bükk
 rendelés: 1000db/csomag
00003320100



Párkány összehúzó
 anyag: cink öntvény
 rendelés: db
00003309000

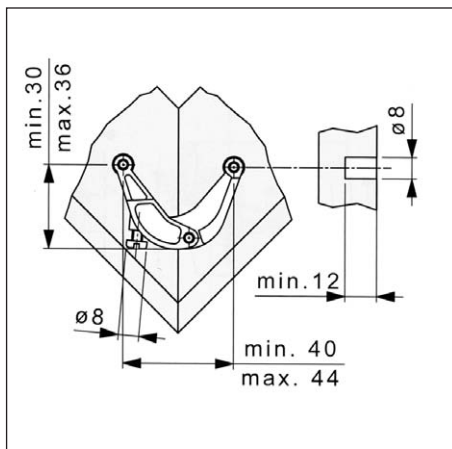

7.92 Szerelvények • Összehúzó

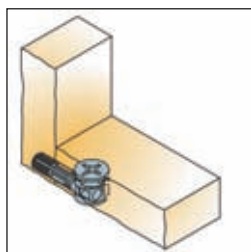
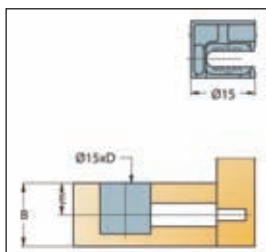

Típus	B (mm)	D (mm)	E (mm)
05656	18/19	14	9-9,5
05644	15/16	12,7	7,5-8
05653	12/13	10,9	6-6,5

05656
Excenter ház $\varnothing 15 \times 13,2$ mm
 anyag: cink
00003315000

05644
Excenter ház $\varnothing 15 \times 11,9$ mm
 anyag: cink
00003315020

05653
Excenter ház $\varnothing 15 \times 10,4$ mm
 anyag: cink
00003315010



01026
Műanyag takarósapka
 méret: $\varnothing 17$ mm
 fehér
00003315100
 barna
00003315101
 fekete
00003315102

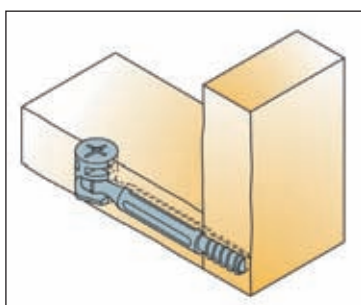
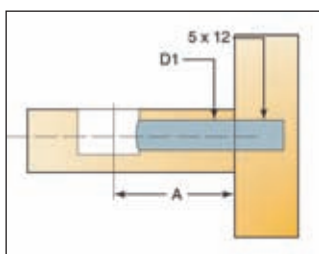

05534
Excenter szár, famenetes
 méret: $\varnothing 7 \times 34$ mm
 anyag: cink
00003315070

A (mm)	D1 (mm)
34	7-8

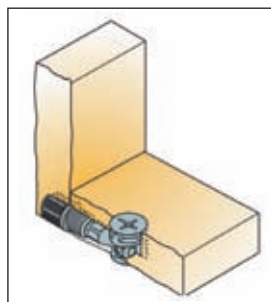
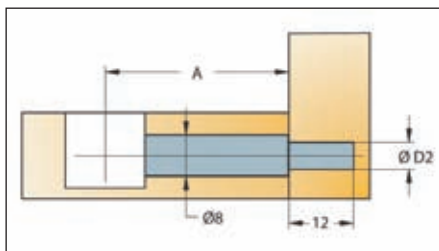

05554
Gyorszerelős excenter szár
 méret: $\varnothing 8 \times 34$ mm
 anyag: cink-műanyag
 mélységhatároló gallérral
00003315060

A (mm)	D2 (mm)
34	7-8

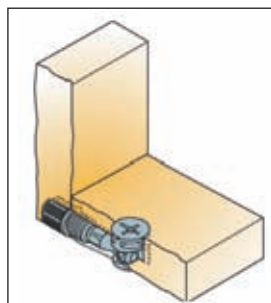
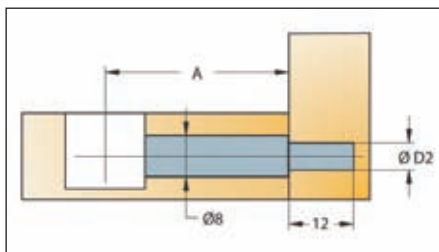

05572
Gyorszerelős excenter szár
 méret: $\varnothing 10 \times 34$ mm
 anyag: cink-műanyag
 mélységhatároló gallérral
00003315050

A (mm)	D2 (mm)
34	10

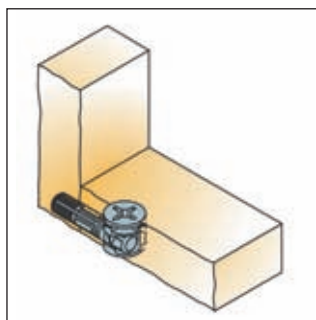
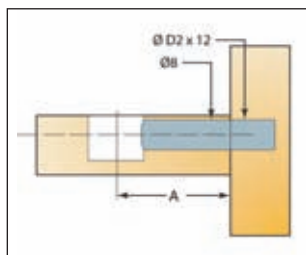

05474
TL2 gyorszerelős excenterszár
 mélységi toleranciával
 méret: Ø8 x 34 mm
 anyag: cink-műanyag
00003315030

A (mm)	D2 (mm)
34 (33-37)	8

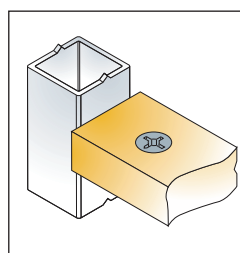
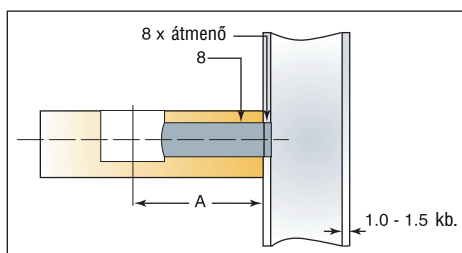

05414
PF2 gyorszerelős excenter
szár fém lábakhoz
 méret: Ø8 x 24 mm
 anyag: cink-műanyag
00003315040

A (mm)
24

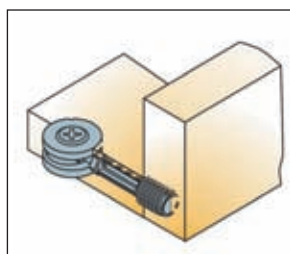
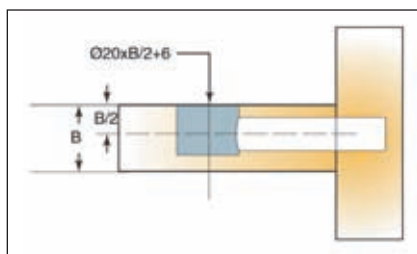
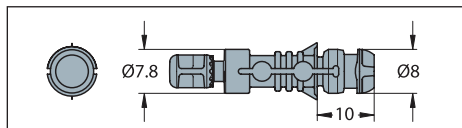

05409
Nagy teherbírású excenter
ház
 méret: Ø20 x 13 mm
 anyag: cink
00003315090

B (mm)
min. 18

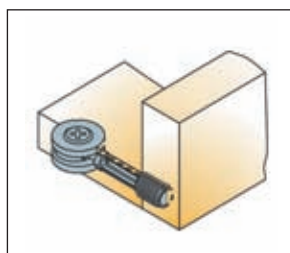
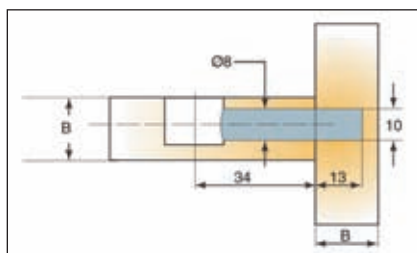

05410
Nagy teherbírású excenter
szár
 méret: Ø10 x 34 mm
 anyag: cink
00003315080

B (mm)
min. 18

7.94 Szerelvények • Összehúzó

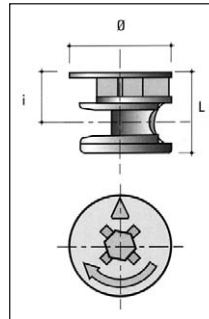
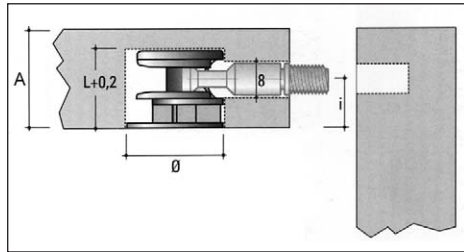
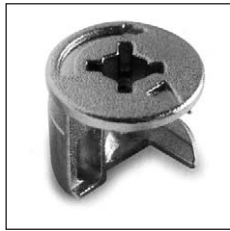

EC02
Excenter ház $\varnothing 15$ mm
 anyag: nyers cink
00003310000

EC03
Excenter ház $\varnothing 15$ mm
 anyag: nyers cink
00003310010

típus	L (mm)	i (mm)	A (mm)
EC02	12,5	8	16
EC03	14	9,5	18-20

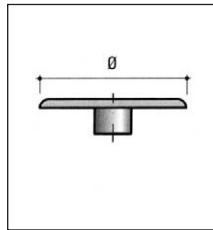

CF04
Takarósapka
 Az EC típusú excenter házhoz
 méret: $\varnothing 17$ mm
 fehér **00003310040**
 barna **00003310041**
 fekete **00003310042**

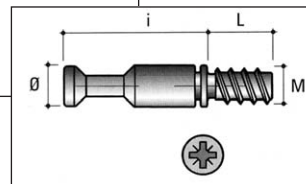
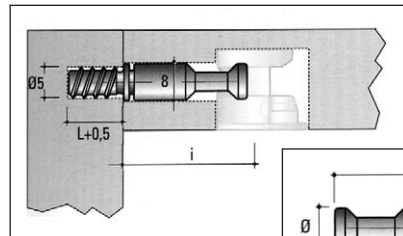

TE01
Excenter szár, famenetes
 felület: horganyzott

\varnothing (mm)	L (mm)	i (mm)
7	11	34

00003310020

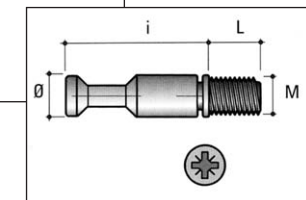
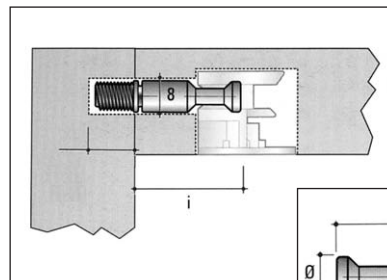

TE03
Excenter szár, M6
 felület: horganyzott
00003310022

TE07
Excenter szár, M4
 felület: horganyzott
00003310021

típus	\varnothing (mm)	L (mm)	i (mm)	M
TE03	7	8	34	M6
TE07	7	8	34	M4

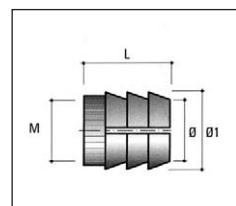
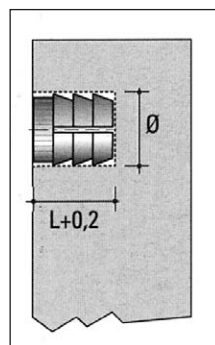

BU11
Műanyag dübel, M4
00003310030

BU18
Műanyag dübel, M6
00003310031

típus	\varnothing (mm)	$\varnothing 1$ (mm)	L (mm)	M
BU11	8	9	10	M4
BU18	10	11	11	M6

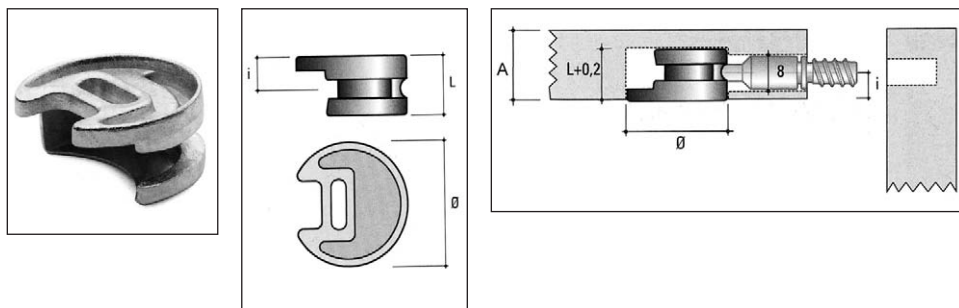

EC12
Excenter ház $\varnothing 25$ mm
 anyag: nyers cink

L (mm)	i (mm)	A (mm)
11,5	7	19

00003310050

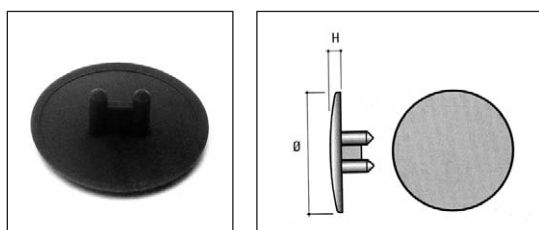

CF08

Takarósapka

Az EC12 típusú excenter házhoz
 méret: $\varnothing 30$ mm

fehér **00003310070**

barna **00003310071**

fekete **00003310072**

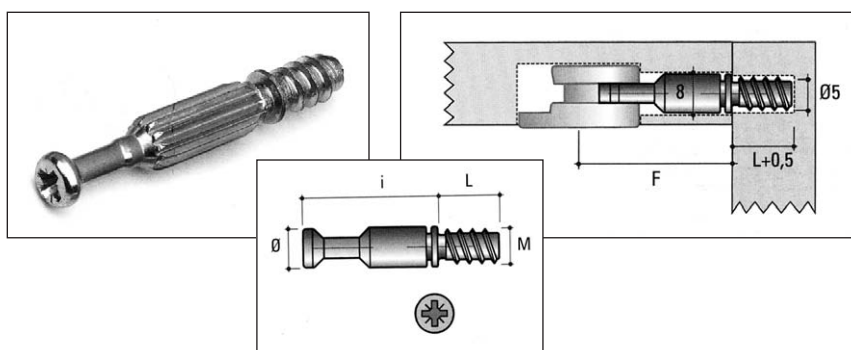

TE28

Excenter szár, famenetes

felület: horganyzott

\varnothing (mm)	i (mm)	L (mm)	F (mm)
7	28	11	33,5

00003310060

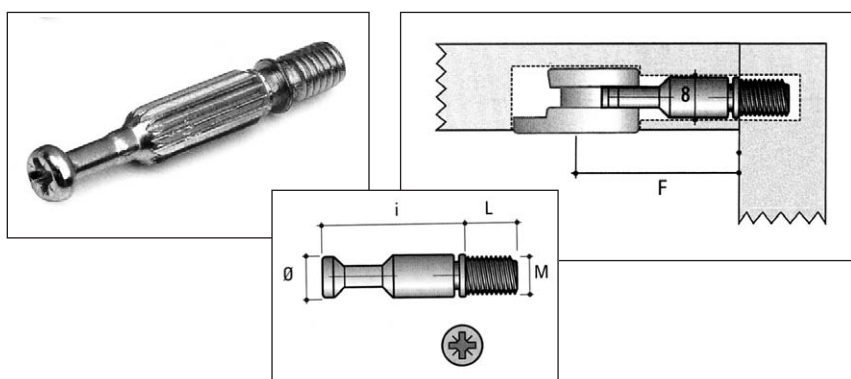

TE16

Excenter szár, M6

felület: horganyzott

\varnothing (mm)	i (mm)	L (mm)	F (mm)
7	28	8	33,5

00003310061

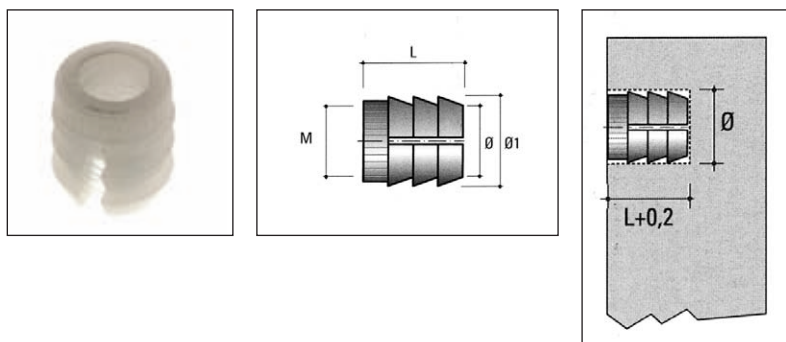

BU18

Műanyag dübel, M6

\varnothing (mm)	$\varnothing 1$ (mm)	L (mm)	M
10	11	11	M6

00003310031

7.96 Szerelvények • Összehúzó

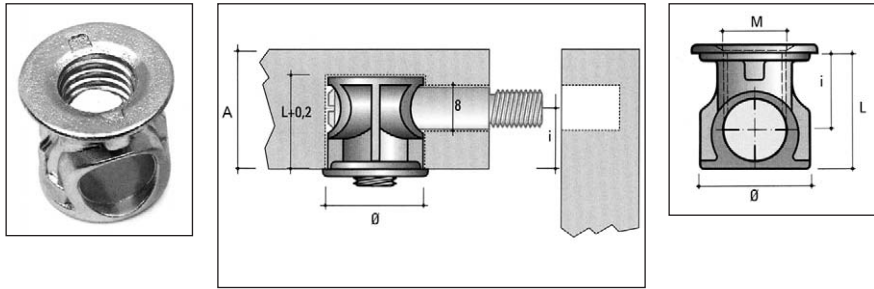

B001
Összehúzó ház $\varnothing 14$ mm
felület: horganyzott

L (mm)	i (mm)	A (mm)	M
14	9,5	19	M8

00003310080



GR01
Rögzítő csavar
A B001 összehúzó házhoz
felület: horganyzott
méret: M8 x 10 mm
00003310100

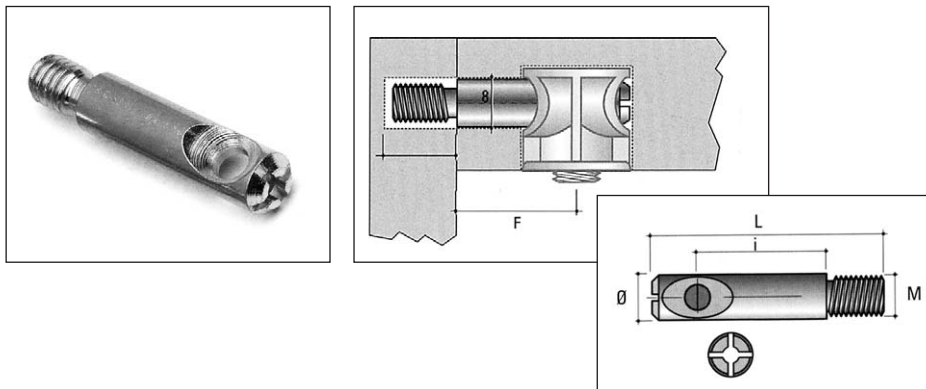

TF03
Összekötő szár, M6
felület: horganyzott
00003310090

TF12
Összekötő szár, famenetes
felület: horganyzott
00003310091

típus	L (mm)	i (mm)	F (mm)	M
TF03	45	28,5	30	M6
TF12	38	20	21,5	-

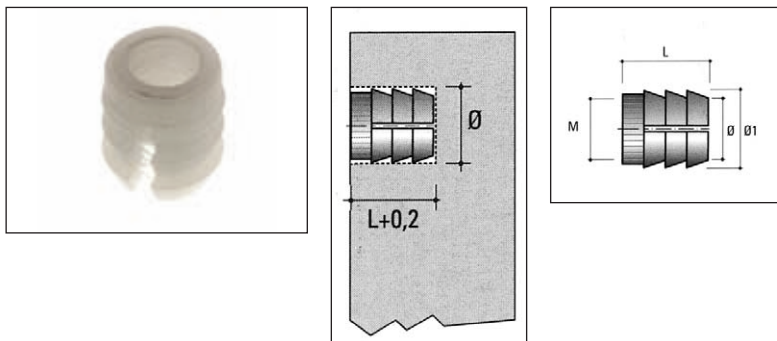

BU18
Műanyag dübel, M6

Ø (mm)	Ø1 (mm)	L (mm)	M
10	11	11	M6

00003310031

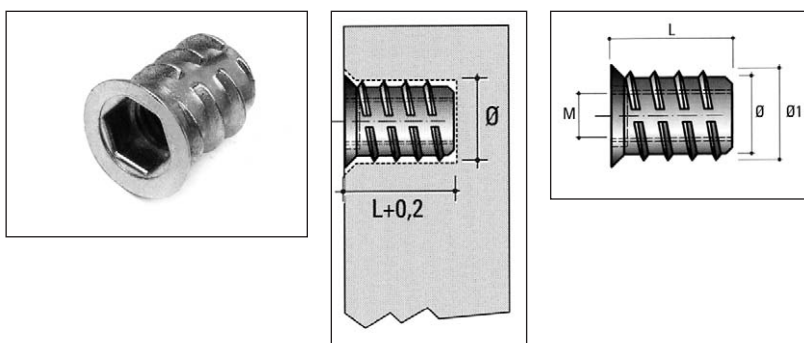

BU01
Fém dübel, M6
00003310110

BU05
Fém dübel, M8
00003310111

típus	Ø (mm)	Ø1 (mm)	L (mm)	M
BU01	8	9,5	13	M6
BU05	10	12	15	M8

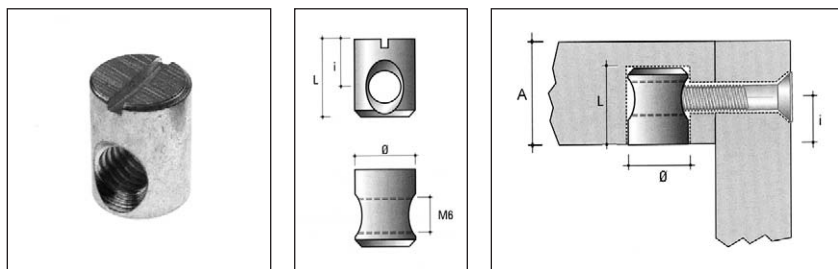

BA02
Tönkanya $\varnothing 10$ mm
felület: horganyzott

L (mm)	i (mm)	A (mm)
14	9,5	19

00003310160

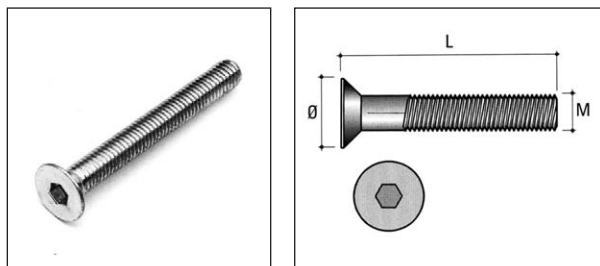

VG02
Összehúzó csavar, M6
a BA02 tönkanyához
felület: horganyzott

L (mm)	Ø (mm)
50	12

00003310150

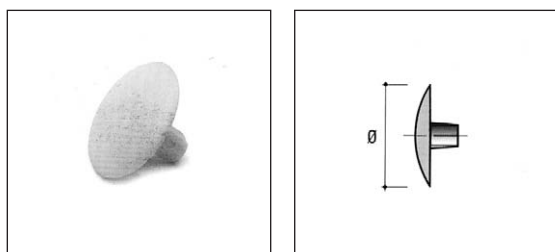

CV02
Takarósapka
A VG02 összehúzó csavarhoz
méret: $\varnothing 14$ mm
fehér 00003310170
barna 00003310171
fekete 00003310172

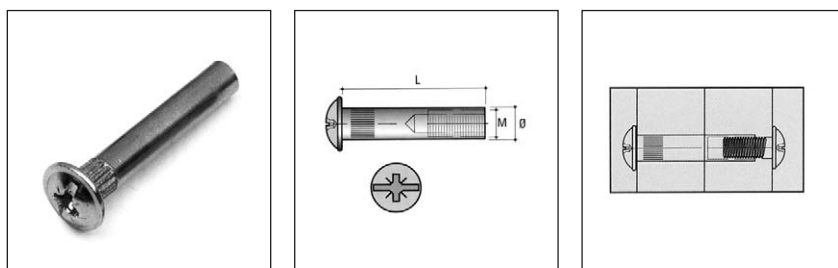

VF04
Korpuz összehúzó ház, $\varnothing 5$ mm
felület: horganyzott

Ø (mm)	L (mm)	M
5	30	M4

00003302300

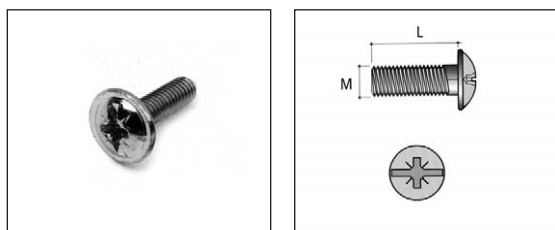

VC01
Korpuz összehúzó csavar, M4
felület: horganyzott
L= 15 mm
00003302310

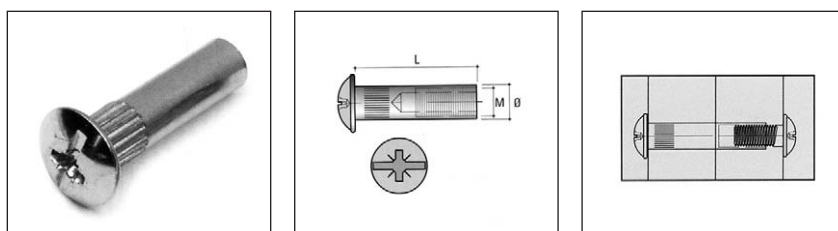

VF03
Korpuz összehúzó ház, $\varnothing 8$ mm
felület: horganyzott

Ø (mm)	L (mm)	M
8	30	M6

00003302320

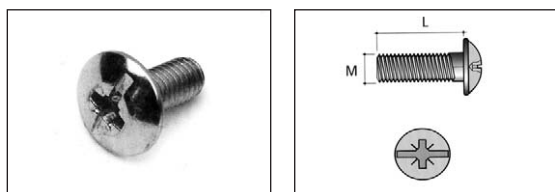

VC05
Korpuz összehúzó csavar, M6
felület: horganyzott
L=14 mm
00003302330

7.98 Szerelvények • Összehúzó

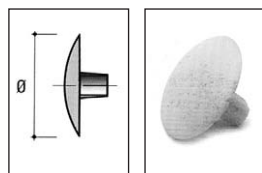
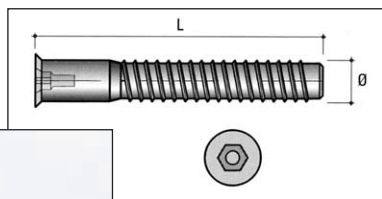

VG Konfirmátor csavar
felület: horganyzott
VG01 $\varnothing 7 \times 50$ mm
00003302200
VG05 $\varnothing 5 \times 50$ mm
00003302210

07002.006 Konfirmátor csavar
 $\varnothing 7 \times 50$ mm pozi **00003302201**
 $\varnothing 7 \times 50$ mm hexa **00003302202**
07002.002 Konfirmátor csavar
 $\varnothing 5 \times 50$ mm pozi **00003302211**
 $\varnothing 5 \times 50$ mm hexa **00003302212**

CV01

Takarósapka

A VG konfirmátor csavarokhoz
méret: $\varnothing 12$ mm
fehér **00003302220**
fekete **00003302221**
barna **00003302222**

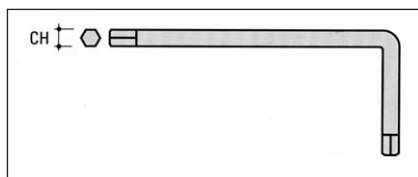

CH01

Imbuszkulcs, 4-es

00003302230

CH02

Imbuszkulcs, 3-as

00003302240

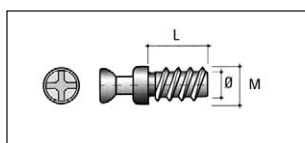
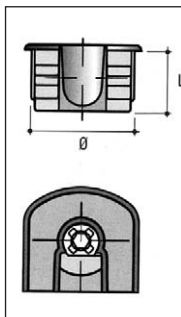
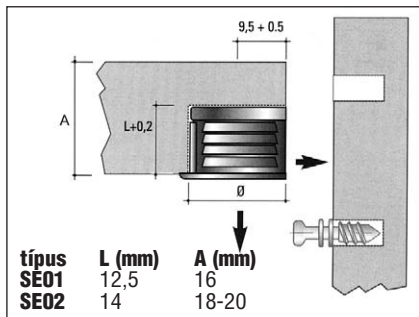

SE01 Excenteres

polcösszehúzó $\varnothing 20$ mm

16 mm vastagságú polcokhoz.

fehér **00003310120**

barna **00003310121**

fekete **00003310122**

SE02 Excenteres

polcösszehúzó $\varnothing 20$ mm

18 mm vastagságú polcokhoz.

fehér **00003310130**

barna **00003310131**

fekete **00003310132**

TI06 Rögzítőcsavar, famenetes

Az SE excenteres
polcösszehúzókhöz
méret: $\varnothing 5 \times 11$ mm
00003310140

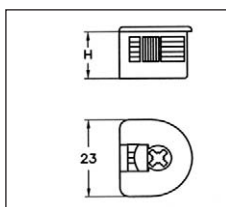
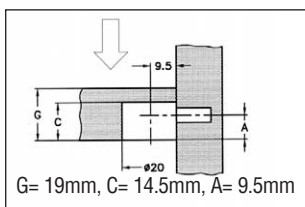

274.9493 Excenteres

polcösszehúzó $\varnothing 20$ mm

18 mm vastagságú polcokhoz.

felület: nikkelt

00003301900

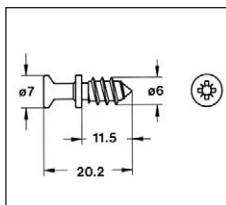
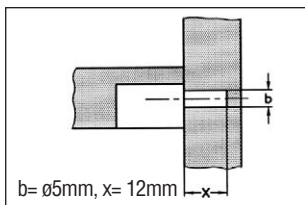

274.6333 Rögzítőcsavar,

famenetes

A 274. excenteres
polcösszehúzóhoz
Egyes polc szereléséhez
felület: horganyzott
00003301910

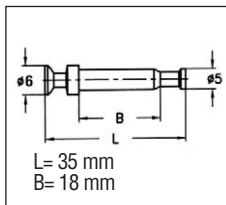
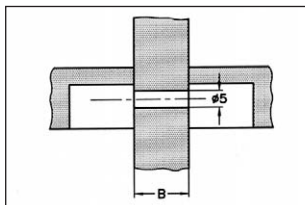

274.2342 Rögzítőcsap

A 274. excenteres
polcösszehúzóhoz
Dupla polc szereléséhez
felület: horganyzott
00003301921

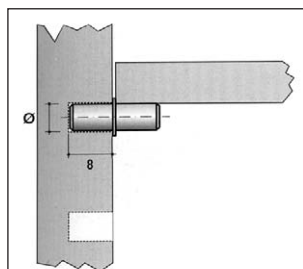
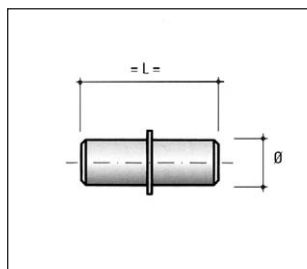

37117 Csapos polctartó
felület: horganyzott
méret: $\varnothing 5 \times 16$ mm
00013600002

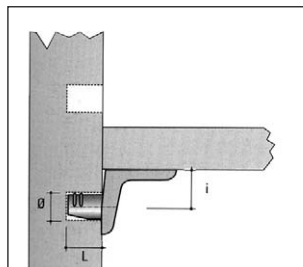
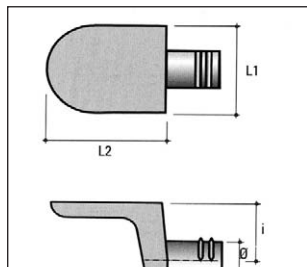

ME05
Körmös polctartó

Ø (mm)	L (mm)	L1 (mm)	L2 (mm)	i (mm)
5	7,5	11	14	6

nikkel **00013600020**
bronz **00013600021**

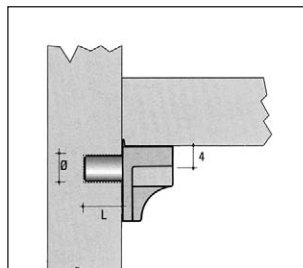
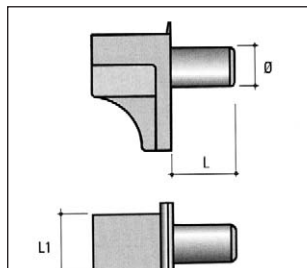

ME13
Csapos polctartó
anyag: fém-műanyag

Ø (mm)	L (mm)	L1 (mm)	L2 (mm)
5	8	8	9

00013600030

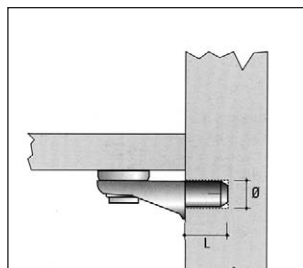
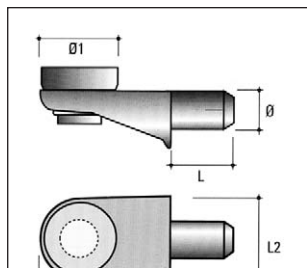

MV01
Csapos üvegpalc tartó
anyag: fém-műanyag

Ø (mm)	L (mm)	L1 (mm)	L2 (mm)	Ø1 (mm)
5	9	20	13	11

nikkel **00013600040**
bronz **00013600041**

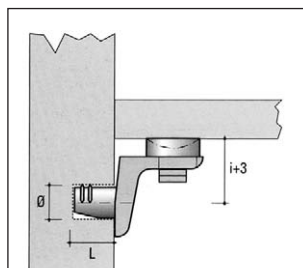
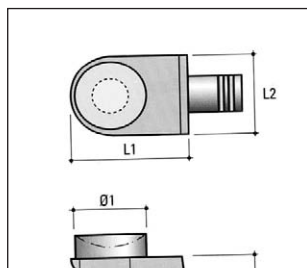

MV03
Körmös üvegpalc tartó
anyag: fém-műanyag

Ø (mm)	L (mm)	L1 (mm)	L2 (mm)	Ø1 (mm)	i (mm)
5	8	14	12	11	6

nikkel **00013600050**
bronz **00013600051**

7.100 Szerelvények

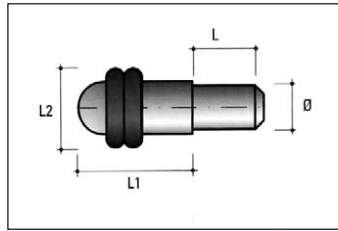
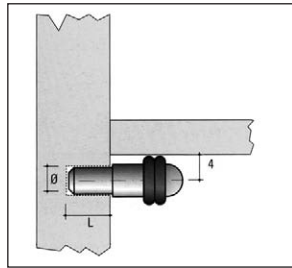

MV06
Csapos üvegpolec tartó
anyag: fém-műanyag

Ø (mm)	L (mm)	L1 (mm)	L2 (mm)
5	8	12	9

nikkel **00013600060**
bronz **00013600061**

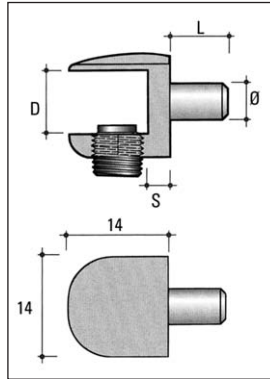
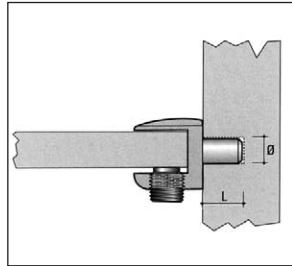

MV08
Csapos üvegpolec tartó
anyag: fém-műanyag

Ø (mm)	L (mm)	D (mm)	S (mm)
5	8	9	3

nikkel **00013600070**
bronz **00013600071**



fehér **00013701000**
fekete **00013701001**
vil. szürke **00013701002**
bükk **00013701003**
nat. tölgy **00013701004**
cserezsnye **00013701005**

fenyő **00013701006**
dió **00013701007**
vil. kőris **00013701008**
wenghe **00013701009**
sötét cser. **00013701010**
mogyoró **00013701011**
metál szürke **00013701012**
körte **00013701013**
D344 ör. cser. **00013701014**

463 juhar **00013701015**
410 cs. feny. **00013701016**
D451 h. bükk **00013701017**
D685 éger k. **00013701018**
D722 mogyor. **00013701019**
428 mahagóni **00013701020**
D740 n. tölgy **00013701021**
444 fr. éger **00013701022**
D1352 vadkör. **00013701023**

Öntapadós
műanyag csavartakaró
kiszerezés: 25db/levél
méret: Ø13 mm

D708 p. tölgy **00013701024**
403 p. cser. **00013701025**
U522 beige **00013701026**
D775 redwood **00013701027**
D1353 vadkör. **00013701028**
458 a. cser. **00013701029**

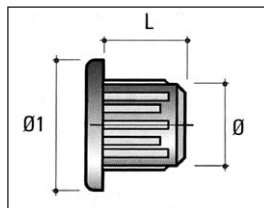

CF01, CF02, CF03
Furattakaró
anyag: műanyag

típus	Ø (mm)	L (mm)	Ø1 (mm)
CF01	5	5	8
CF02	8	8	12
CF03	10	8	14

	CF01	CF02	CF03
fehér	00013701100	00013701110	00013701120
fekete	00013701101	00013701111	00013701121
barna	00013701102	00013701112	00013701122

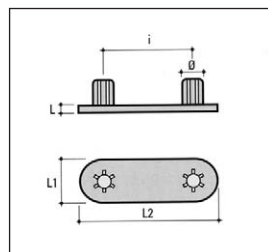

SC01 Padlóvédő
anyag: műanyag

Ø (mm)	L (mm)	L1 (mm)	L2 (mm)	i (mm)
8	3	16	50	32

fekete **00015505300**
barna **00015505305**
fehér **00015505310**

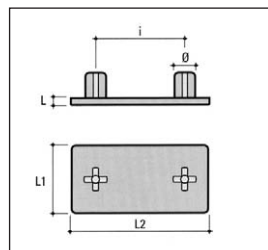

SC02 Padlóvédő
anyag: műanyag

Ø (mm)	L (mm)	L1 (mm)	L2 (mm)	i (mm)
8	3	25	50	32

fekete **00015505315**
barna **00015505320**